

E029ZML827ASS | Keplero Quantum 130

Recessed professional projector with an adjustable optical unit

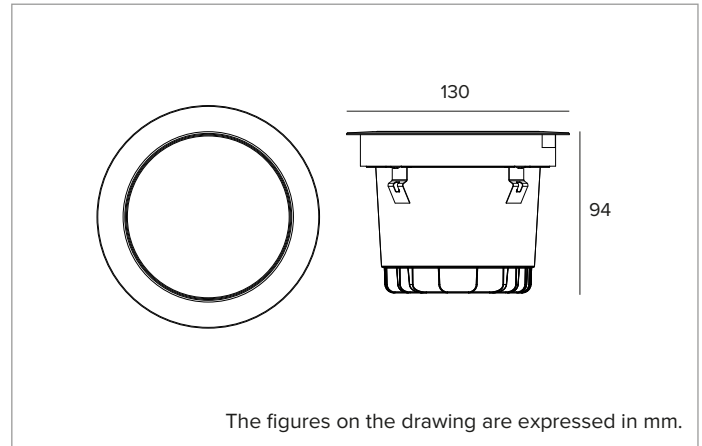

The fixture's photometric values can be found on the following pages



The figures on the drawing are expressed in mm.

SOURCE

High efficiency Chip on Board LED. 2700K (Ra80) colour temperature.

Energy efficiency class: C

Nominal power: 12W

Nominal flux: 1867lm

Colour rendering index: 80

Rf: 80

Rg: 97

CCT nominal: 2700K

ILLUMINOTECHNICAL CHARACTERISTICS

Optical system made of a double optical grade PMMA lens and a holographic diffusing filter for continuous adjustment of the beam angle (from Spot to Medium Wide Flood). Adjustability of the optical unit up to 20° on the vertical plane. Tilting of the optical unit and adjustment of the beam angle made through external regulations without opening the product.

Optic: ZOOM

Beam angles: SP-MWFL

Optical efficiency: See photometries

Fixture flux: See photometries

Luminous efficacy: See photometries

Photobiological safety: Compliant with RG1 low risk group

MECHANICAL CHARACTERISTICS

Die-cast aluminium body with 2 layers of protection: cataphoresis and black paint. Ultra flat decorative ring with a flared edge, made of brushed stainless steel (AISI 316) in a natural finish. Anti-slip glass for public pedestrian areas.

Colour and finish: Brushed stainless steel

Version: ANTI-SLIP GLASS

Degree of protection: IP66,IP67,IP68

Mechanical Resistance: IK10

ELECTRICAL CHARACTERISTICS

24Vdc power supply. ON-OFF or DALI2 remote driver to be ordered separately. Precabled with 1,5m 2x0,5mm² cable. Casambi control system available via accessory (for products with DALI2 driver only).

Fixture Power: 13W

Power supply: 24Vdc

Insulation Class: CLASS 3

Driver included: NO

Class F: YES

Ambient temperature: -25°C / +35°C

INSTALLATION

In-ground installation by a reinforced nylon sleeve, to be ordered separately. Sleeves are available for flush or trim installation. 20kN resistance to static load. Wall/ceiling installation by the accessory mounting systems.

NOTES

IP68: the fixture is not suitable for permanent underwater installation but can withstand temporary accidental immersion to a depth of 1.5 metres (max.1h). All the Keplero Quantum 130 versions meet the drive-over and walk-over requirements set out in the EN 60598-2-13 standard. It features the "Waterblock Smart" technical solution which involves resin-sealing the connection cables to minimize the risk of moisture rising into the fixture. Commissioning of the control system via free APP; the intervention of a specialist technician can be quoted on request.

WARRANTY

5 years.

WARNING

Luminaire designed for disposal/recycling at end-of-life. Replaceable (LED only) light source by a professional. Non-replaceable control gear.

Due to the technological evolution of the electronic components, the data provided may be updated, and as such, confirmation must be requested during the order process.

Luminous flux and power supply have +/-10% tolerances with respect to the indicated value. tq +25°C (CIE 121).

We reserve the right to make technical changes.

Targetti Sankey S.r.l.
Via Pratese, 164
50145 Firenze - Italy
Tel: +39 055 37911
targetti.com
targetti@targetti.com

CCIAA Firenze
Share Capital:
€ 500.000,00
VAT N. (IT):
01537660480
R.E.A.: FI-275656

TARGETTI

E029ZML827ASS | Keplero Quantum 130

Recessed professional projector with an adjustable optical unit



	2700K	H(m)	D(m)	Emax(lx)		
	Ra80		16°			
Fixture Power	13W	1	0.29	9174		
Source Flux	1867lm	2	0.58	2293		
Fixture Flux	1172lm	3	0.87	1019		
Efficacy	89lm/W	4	1.16	573		
TS2033	Imax=4914cd/klm	Imax	9174cd	5	1.45	367



	2700K	H(m)	D(m)	Emax(lx)		
	Ra80		42°			
Fixture Power	13W	1	0.77	2028		
Source Flux	1867lm	2	1.54	507		
Fixture Flux	1129lm	3	2.31	225		
Efficacy	86lm/W	4	3.08	127		
TS2034	Imax=1086cd/klm	Imax	2028cd	5	3.85	81

SP

Fixture flux	1172lm
Luminous efficacy	89lm/W
Optical efficiency	63%

WFL

Fixture flux	1129lm
Luminous efficacy	86lm/W
Optical efficiency	60%

Due to the technological evolution of the electronic components, the data provided may be updated, and as such, confirmation must be requested during the order process.

Luminous flux and power supply have +/-10% tolerances with respect to the indicated value. tq +25°C (CIE 121).

We reserve the right to make technical changes.

Targetti Sankey S.r.l.
Via Pratese, 164
50145 Firenze - Italy
Tel: +39 055 37911
targetti.com
targetti@targetti.com

CCIAA Firenze
Share Capital:
€ 500.000,00
VAT N. (IT):
01537660480
R.E.A.: FI-275656

TARGETTI

E029ZML827ASS | Keplero Quantum 130

Recessed professional projector with an adjustable optical unit

Related codes

Sleeve



L mm	H mm	P mm	Code
317	125	317	A121

Reinforced nylon installation sleeve.
The sleeve is designed for the trim installation of the fixture.
Complete with a cover element to protect the recessed housing during concrete pouring.
Ax/B 317x317 H. 125



L mm	H mm	P mm	Colour	Code
317	127	317		A122SS

Reinforced nylon installation sleeve.
The sleeve is designed for the flush installation of the fixture.
Complete with a cover element to protect the recessed housing during concrete pouring.
Ax/B 317x317 H. 127

Mounting System



Code

A123

Steel spring kit for wall and ceiling installations.

Power Supply

Dimensions LxHxP mm	Power	Power supply	Output voltage	IP	Code
171x37x62	60W MAX	220-240Vac	24Vdc	IP67	A134EL
228x39x68	150W MAX	220-240Vac	24Vdc	IP67	A137EL

Electronic ON-OFF power supply.

Dimensions LxHxP mm	Power	Power supply	Output voltage	IP	Code
150x35x53	60W MAX	220-240Vac	24Vdc	IP67	A134D2
191x38x63	120W MAX	220-240Vac	24Vdc	IP67	A136D2

DALI2 power supply.

Accessories

Connector



Code

1E2493

Linear connection box IP68.
4 poles max. wire section 2.5mm².
Cable diameter range from 7 to 12mm.



Code

1E2494

Multiple connection box IP68.
1 IN - 3 OUT 4 poles max. wire section 2.5mm².
Cable diameter range from 6 to 12mm.

Due to the technological evolution of the electronic components, the data provided may be updated, and as such, confirmation must be requested during the order process.
Luminous flux and power supply have +/-10% tolerances with respect to the indicated value. tq +25°C (CIE 121).

We reserve the right to make technical changes.

Targetti Sankey S.r.l.
Via Pratese, 164
50145 Firenze - Italy
Tel: +39 055 37911
targetti.com
targetti@targetti.com

CCIAA Firenze
Share Capital:
€ 500.000,00
VAT N. (IT):
01537660480
R.E.A.: FI-275656

TARGETTI

E029ZML827ASS | Keplero Quantum 130
Recessed professional projector with an adjustable optical unit

Tool



Code

1E3305

Tightening wrench for the connector kit.

Due to the technological evolution of the electronic components, the data provided may be updated, and as such, confirmation must be requested during the order process.

Luminous flux and power supply have +/-10% tolerances with respect to the indicated value. tq +25°C (CIE 121).

We reserve the right to make technical changes.

Targetti Sankey S.r.l.
Via Pratese, 164
50145 Firenze - Italy
Tel: +39 055 37911
targetti.com
targetti@targetti.com

CCIAA Firenze
Share Capital:
€ 500.000,00
VAT N. (IT):
01537660480
R.E.A: FI-275656

TARGETTI